

# Formwalzenkatalog

für Janssen-Gebäckformer Formfix 1-2-3

# Forming roller catalogue

for Janssen Formfix 1-2-3 Cookie Formers



*Formfix 1-2-3*



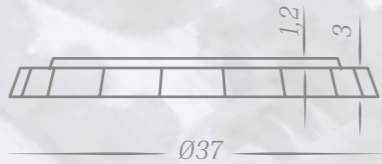

*Inhalt / Content*

»Standardmotive und individuelle Designs« / »Standard motifs and individual designs«  
 »Einleitung« / »Introduction«

*Preiskategorie I / Price category I*

- 4127- »Janssens Buttergebäck « / »Janssen's Butter Biscuits« 11
- 1027- »Janssens herzhaftes Schnittchen« / »Janssen's Savoury Canapés« 13
- 4472- »Janssens Käsegebäck« / »Janssen's Cheese Biscuits« 15
- 4022- »Janssens Linzer« / »Janssen's Linzer« 17
- 1020- »Janssens Brezeln« / »Janssen's Pretzels« 19

*Preiskategorie II / Price category II*

- 0017- »Janssens Kipferl« / »Janssen's Kipferl« 21



**Preiskategorie III / Price category III**

-1016-	»Janssens Osterhase« / »Janssen's Easter Bunny«	23
-1010-	»Janssens Kerlchen« / »Janssen's Little Guys«	25
-1011-	»Janssens Winzerwelt« / »Janssen's World of Vintners«	27
-1012-	»Janssens Kartenwelt« / »Janssen's World of Cards«	29
-4100-	»Janssens Butterkeks« / »Janssen's Butter Cookie«	31
-0028-	»Rheinischer Spekulatius« / »Rhenish Speculoos«	33
-4109-	»Janssens Spekulatius« / »Janssen's Speculoos«	35
-4115-	»Feiner Konditorspekulatius« / »Fine Confectioner's Speculoos«	37
-4113-	»Holländer Gewürzspekulatius« / »Dutch Spiced Speculoos«	39
-4111-	»Janssen's Tierischer Spekulatius« / »Janssen's Animal Speculoos«	41
-1002-	»Janssens Kleine Welt« / »Janssen's Little World«	43
-1003-	»Janssens Halloween Welt« / »Janssen's Halloween World«	45
-1004-	»Janssens Osterwelt« / »Janssen's Easter World«	47
-1009-	»Janssens Herbstwelt« / »Janssen's Autumn World«	49
-1006-	»Janssens Nikolauswelt« / »Janssen's Santa's World«	51
-1001-	»Janssens Weihnachtswelt« / »Janssen's Christmas World«	53
-1015-	»Janssens Kleine Waldwelt« / »Janssen's Little Forest World«	55



-1005-	»Janssens Märchenwelt« / »Janssen's Fairytale World«	57
-1007-	»Janssens Gute Besserung Welt« / »Janssen's Get Well World«	59
-1024-	»Janssens Meereswelt« / »Janssen's Sea World«	61
-1441-	»Janssens Engelswelt« / »Janssen's Angle World«	63
-4102-	»Janssens Feines Teegebäck« / »Janssen's Fine Tea Biscuits«	65
-4476-	»Janssens Teegebäck 1« / »Janssen's Tea Biscuits 1«	67
-4478-	»Janssens Teegebäck 2« / »Janssen's Tea Biscuits 2«	69
-4470-	»Janssens Griechisches Gebäck« / »Janssen's Greek Pastry«	71
-4471-	»Janssens Spanisches Gebäck« / »Janssen's Spanish Pastry«	73
-4474-	»Janssens Dekorgebäck« / »Janssen's Decorative Biscuits«	75
-1013-	»Janssens Schneeflocken« / »Janssen's Snowflakes«	77
-1016-	»Janssens Flora« / »Janssen's Flora«	79
-1017-	»Janssens Ornamentgebäck« / »Janssen's Ornamental Biscuits«	81
-1018-	»Janssens Kristalle« / »Janssen's Crystals«	83
-1019-	»Janssens Mandalas« / »Janssen's Mandalas«	85
-1020-	»Janssens süße Zungen« / »Janssen's Sweet Tongues«	87
-1021-	»Janssens Feinstes« / »Janssen's Finest«	89
-1022-	»Janssens Geschenke« / »Janssen's Presents«	91
-1023-	»Janssens Prismen« / »Janssen's Prisms«	93



- 4106- »Janssens Spritzgebäck« / »Janssen's Shortbread« 95  
 -0001- »Janssens Omakeks« / »Janssen's Granny Biscuit« 97  
 -1017- »Janssens Torteletts« / »Janssen's Tartlets« 99

**Preiskategorie IV / Price category IV**

- 1000- »Janssens Kleine Spekuwelt« / »Janssen's Little Speculoos World« 101

**»Individuelle Designs« / »Individual designs« 103**

**Preise auf Anfrage... / Prices on request...**

Beispiel: »Runde Gebäcke« / Example: »Round Biscuits« 105

Beispiel: »... mit Wellenrand« / Example: »... with Scalloped Edge« 107

Beispiel: »Gitter« / Example: »Lattice« 109



## – Einleitung / Introduction –



### »Standardmotive und individuelle Designs«

**Formwalzen mit unseren Standardmotiven**  
– (Seite 11-101).

Die Motivvielfalt der Formwalzen, die in den Janssen-Gebäckformern Formfix 1-2-3 zur Anwendung kommen, ist schier unerschöpflich.

Wir bieten Ihnen ein umfangreiches Repertoire von Standardwalzen mit unseren festgelegten Maßen an, die Sie in diesem Formwalzenkatalog finden.

*Soll es was Besonderes sein?*

**Formwalzen mit ihren individuellen Motiven und Maßen** – (Beispiele Seite 103-109)

Entdecken Sie die gestalterischen Möglichkeiten für Ihre individuellen und unverwechselbaren Kekse: Von Ihrer gebackenen Visitenkarte, Ihrem Logo bis hin zu ganz individuellen grafischen Motiven und Mustern.

Kontaktieren Sie uns und schicken Sie uns ein Foto /Skizze oder beschreiben Sie uns Ihr Wunschgebäck und nennen Sie uns die Maße des ungebakenen Kekses.

### »Standard motifs and individual designs«

**Forming rollers with our standard motifs**  
– (page 11-101).

The variety of designs of the forming rollers used in the Janssen Cookie Formers Formfix 1-2-3 is almost inexhaustible. We offer you an extensive repertoire of standard rollers with our fixed dimensions, which you will find in this forming roller catalogue.

*Would you like something special?*

**Forming rollers with your individual designs and dimensions** – (examples page 103-109)

Discover the design possibilities for your individual and distinctive biscuits: From your baked business card, your logo to completely individual graphic motifs and patterns. Contact us and send us a photo /sketch or describe your desired biscuit and tell us the dimensions of the unbaked biscuit.

- 4127 -



## »Janssens Buttergebäck« / »Janssen's Butter Biscuits«

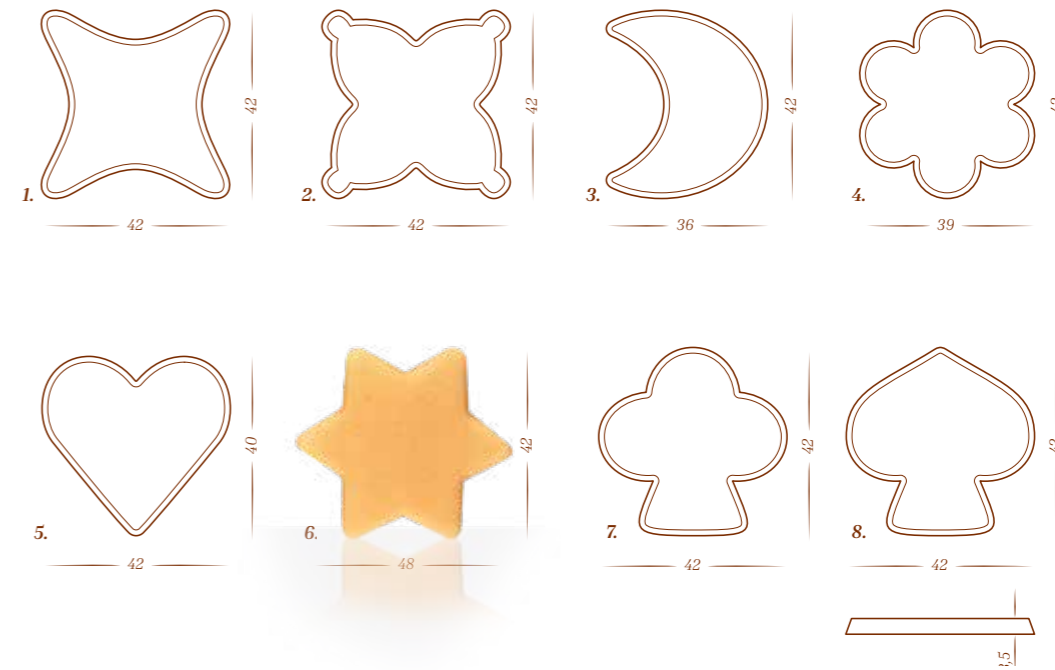

Janssens Buttergebäck Nr.: 4127/1-8. / Janssen's Butter Biscuits No.: 4127/1-8.

Janssen

- 1027 -



## »Janssens herzhafte Schnittchen« / »Janssen's Savoury Canapés«

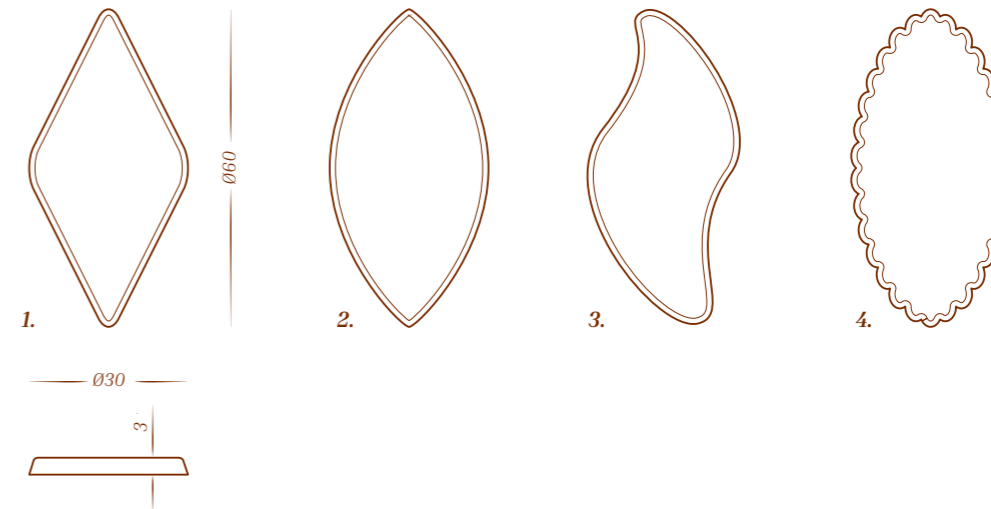

Janssens herzhafte Schnittchen Nr.: 1027/1-4. / Janssen's Savoury Canapés No.: 1027/1-4.

- 4472 -



## »Janssens Käsegebäck« / »Janssen's Cheese Biscuits«

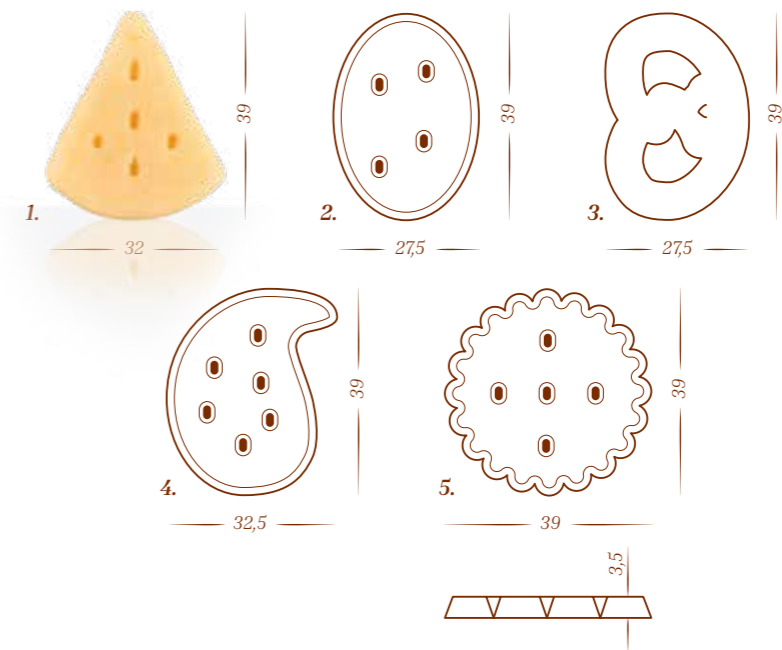

Janssens Käsegebäck Nr.: 4472 / 1-5. / Janssen's Cheese Biscuits No.: 4472 / 1-5.

Janssen



- 4022 -



## »Janssens Linzer« / »Janssen's Linzer«

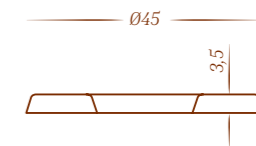
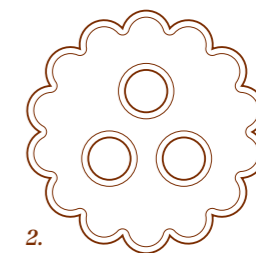
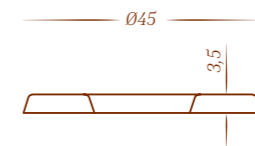
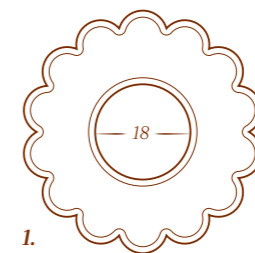
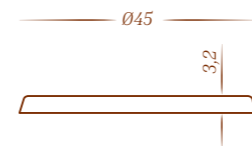
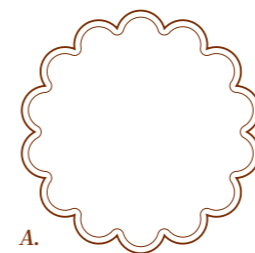

Janssens Linzer Nr.: 4022 / A-1-2. / Janssen's Linzer No.: 4022/ A-1-2.

Janssen

- 1020 -

»Janssens Brezeln« / »Janssen's Pretzels«

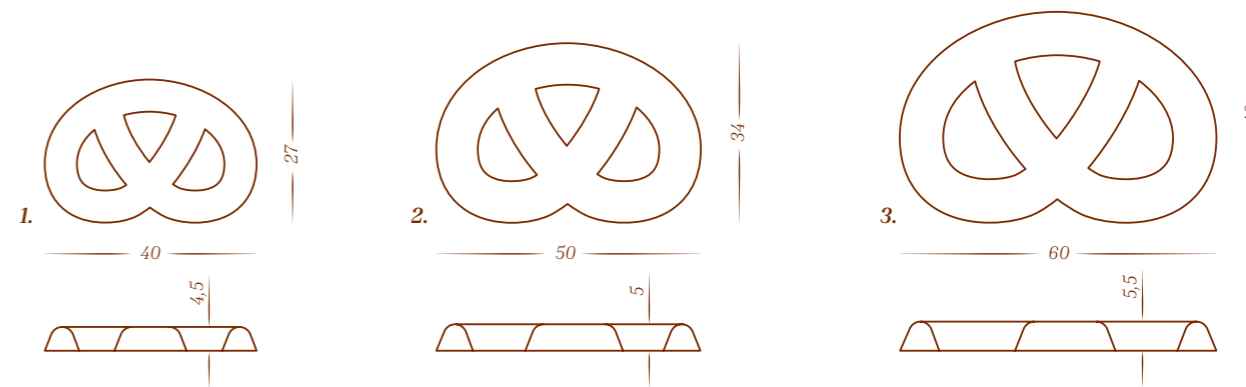

Wählen Sie eine Größe... / Choose a size...

Janssens Brezeln Nr.: 1020 / 1-3. / Janssen's Pretzels No.: 1020 / 1-3.



— 0017 —



»Janssens Kipferl« / »Janssen's Kipferl«

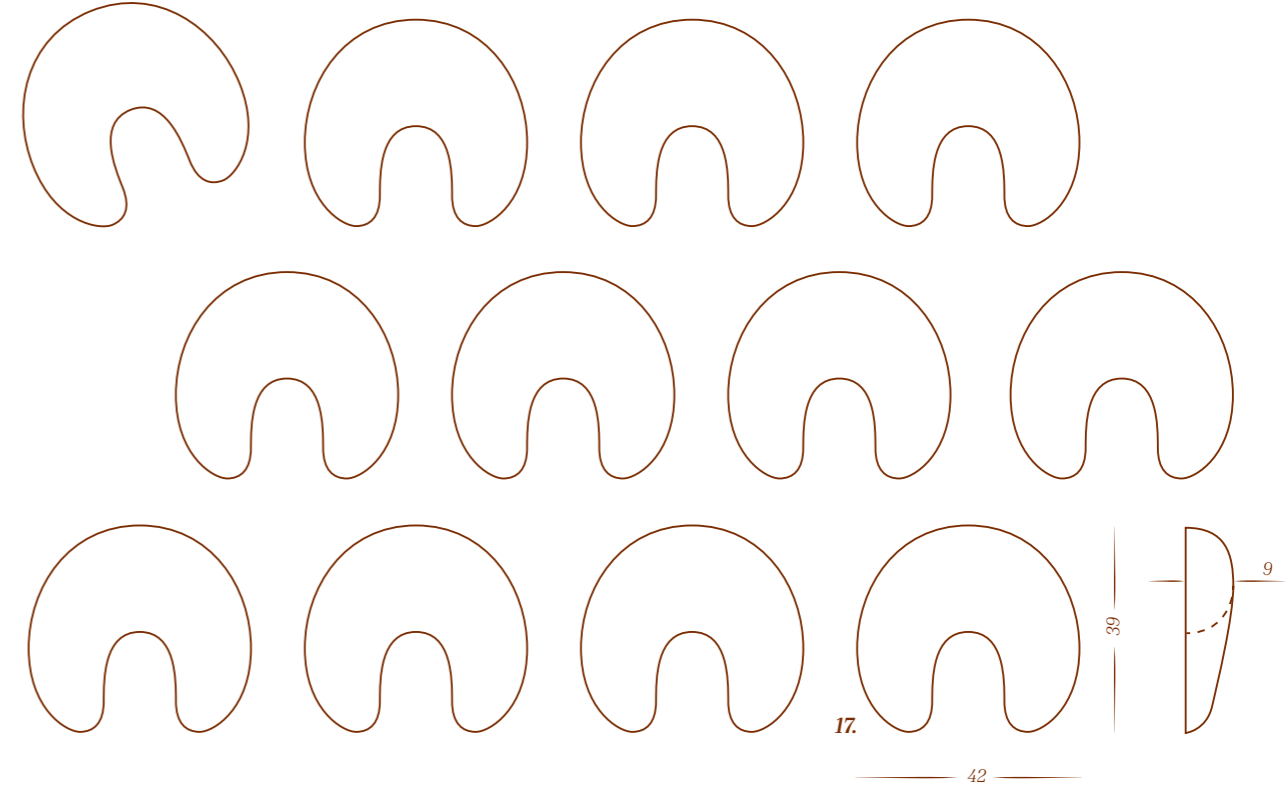

Janssens Kipferl Nr.: 17. / Janssen's Kipferl No.: 17.



- 1014 -

## »Janssens Osterhase« / »Janssen's Easter Bunny«

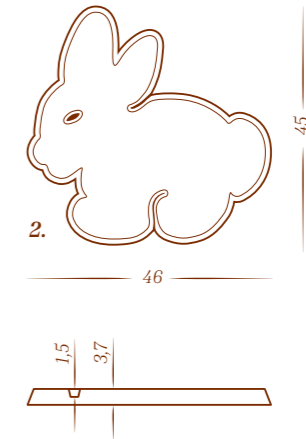
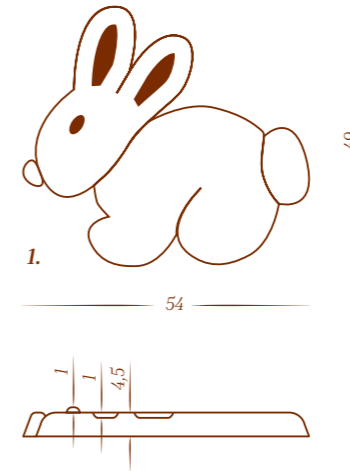

Janssens Osterhase Nr.: 1014 / 1-2. / Janssen's Easter Bunny No.: 1014 / 1-2.



- 1010 -

»Janssens Kerlchen« / »Janssen's Little Guys«

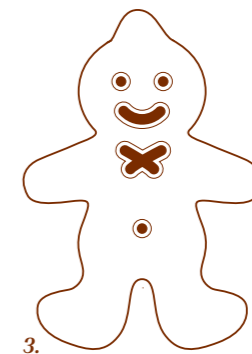

46

63

2

4,5

Mit Schokoladenguss verziert / Decorated with chocolate icing



Janssens Kerlchen Nr.: 1010 / 1-4. / Janssen's Little Guys No.: 1010 / 1-4.

Janssen



– 1011 –

»Janssens Winzerwelt« / »Janssen's World of Vintners«

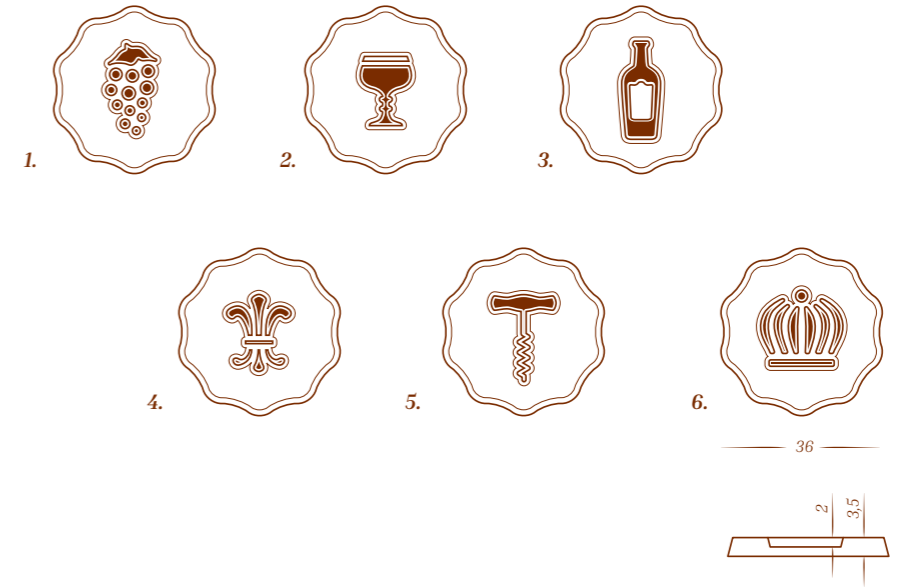

Janssens Winzerwelt Nr.: 1011/1-6. / Janssen's World of Vintners No.: 1011/1-6.



– 1012 –



»Janssens Kartenwelt« / »Janssen's World of Cards«

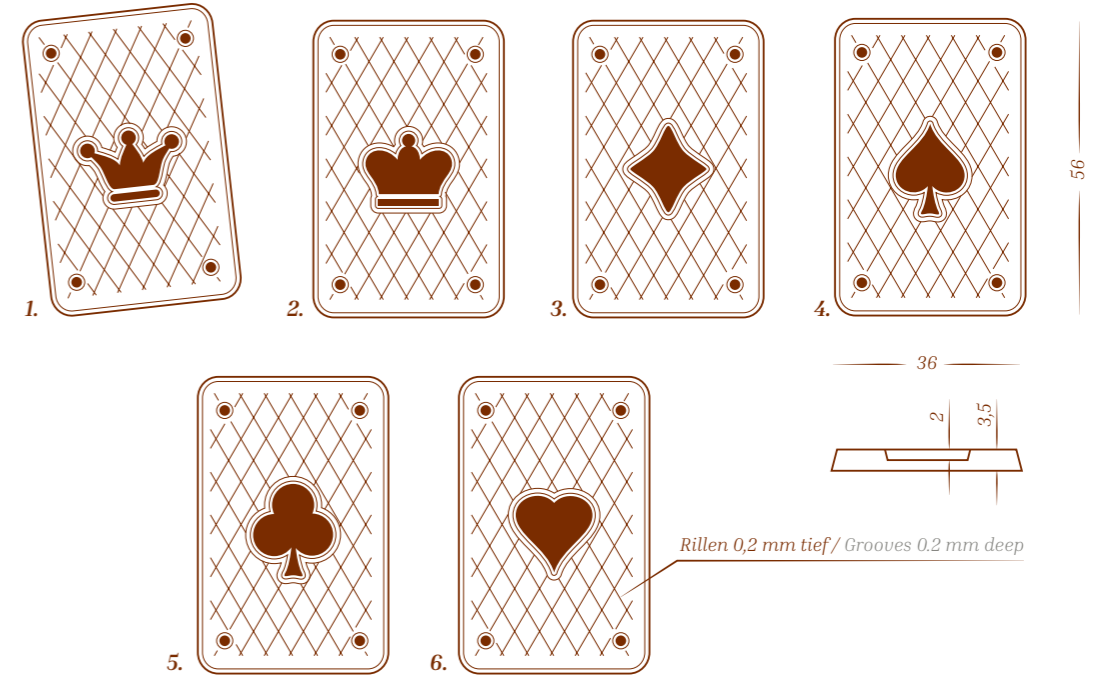

Janssens Kartenwelt Nr.: 1012 / 1-6. / Janssen's World of Cards No.: 1012 / 1-6.



– 4100 –



»Janssens Butterkeks« / »Janssen's Butter Cookie«

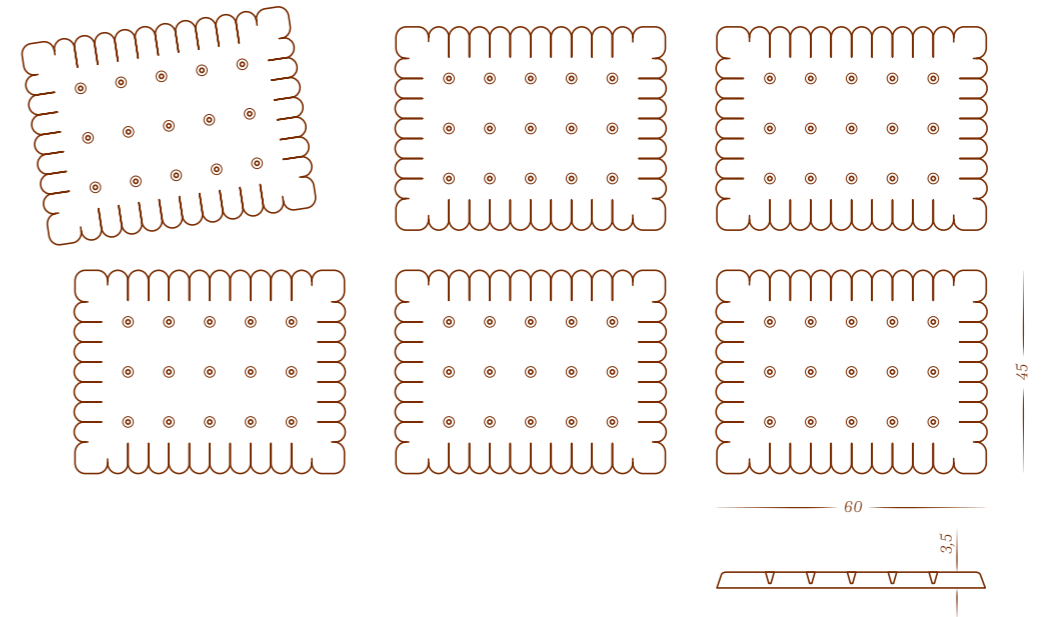

Janssens Butterkeks Nr.: 4100 / Janssen's Butter Cookie No.: 4100





– 0028 –



»Rheinischer Spekulatius« / »Rhenish Speculoos«



Rheinische Spekulatius Nr.: 0028 / 1-12. / Rhenish Speculoos No.: 0028 / 1-12.



– 4109 –



»Janssens Spekulatius« / »Janssen's Speculoos«

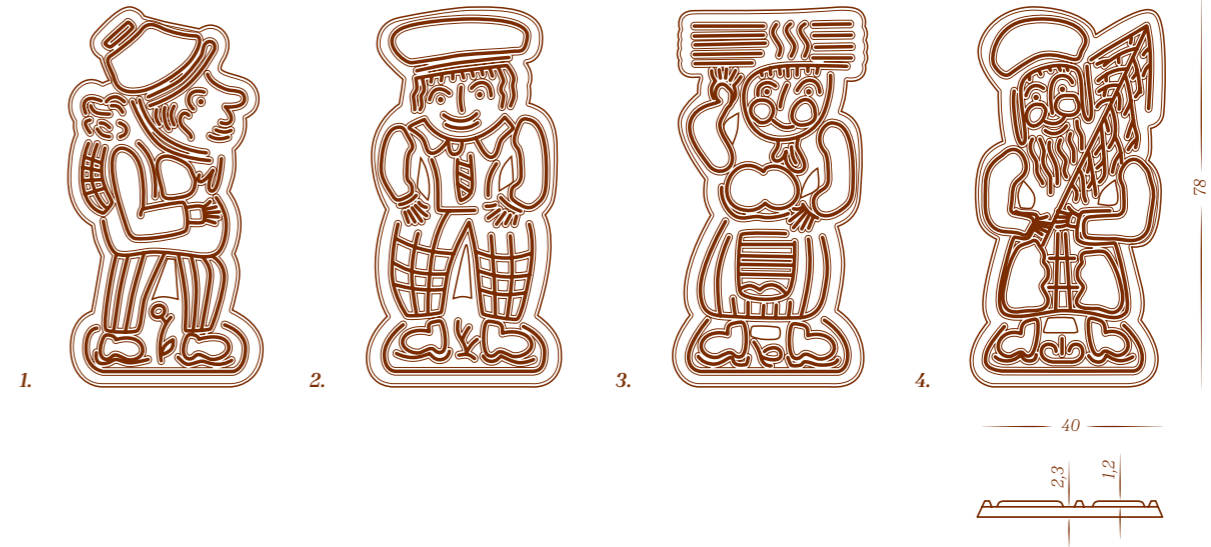

Janssens Spekulatius Nr.: 4109 / 1-4. / Janssen's Speculoos No.: 4109 / 1-4.



- 4115 -



»Feiner Konditorspekulativus« / »Fine Confectioner's Speculoos«

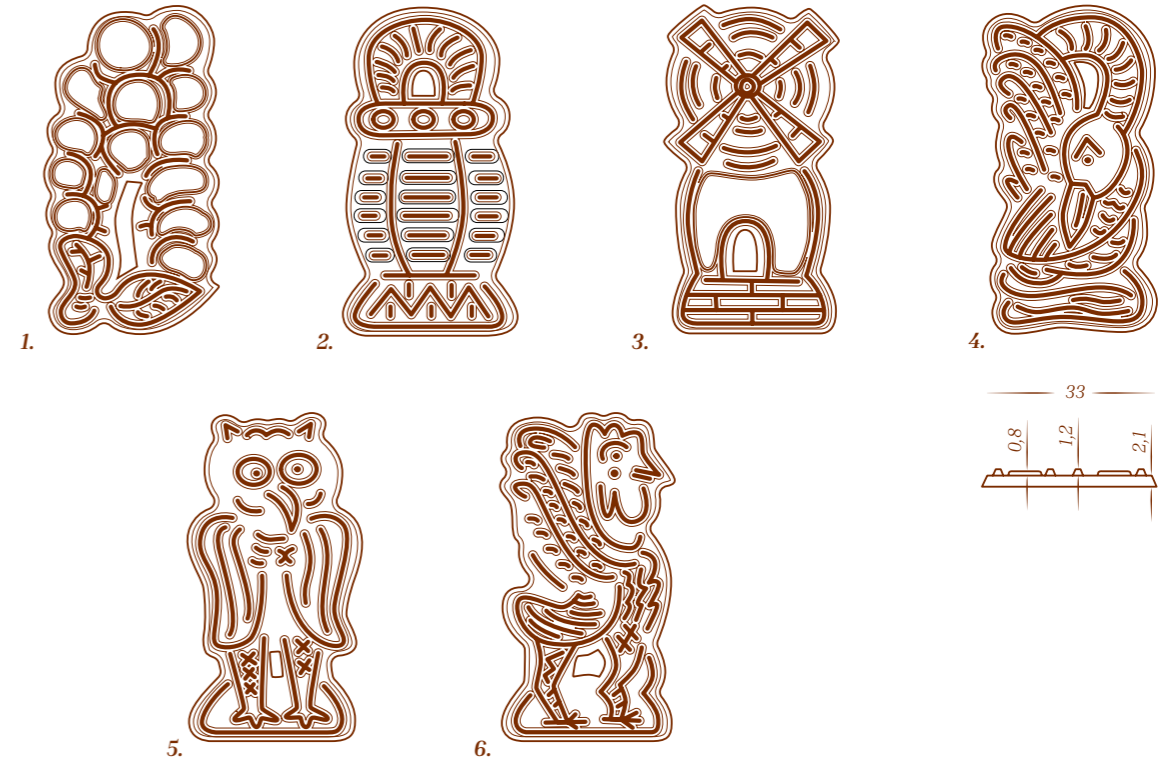

Feiner Konditorspekulativus Nr.: 4115/1-6. / Fine Confectioner's Speculoos No.: 4115/1-6.

– 4113 –



»Holländer Gewürzspekulatius« / »Dutch Spiced Speculoos«



Holländer Gewürzspekulatius Nr.: 4113 / 1-8. / Dutch Spiced Speculoos No.: 4113 / 1-8.



— 4111 —



»Janssens Tierischer Spekulatius« / »Janssen's Animal Speculoos«

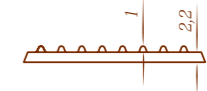
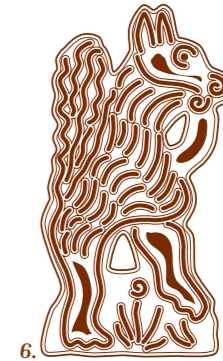
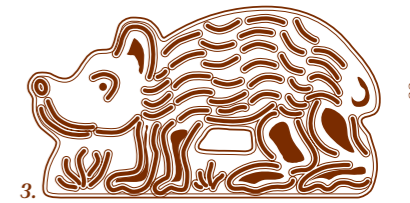
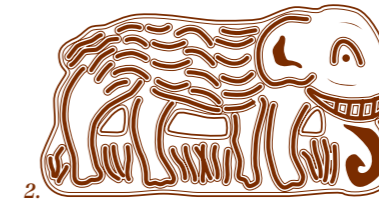
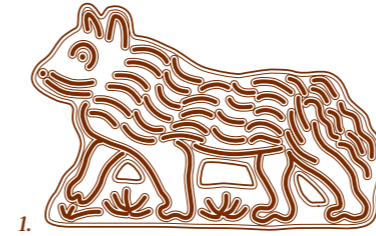

Janssen's Tierischer Spekulatius Nr.: 4111 / 1-6. / Janssen's Animal Speculoos No.: 4111 / 1-6.



– 1002 –



»Janssens Kleine Welt« / »Janssen's Little World«

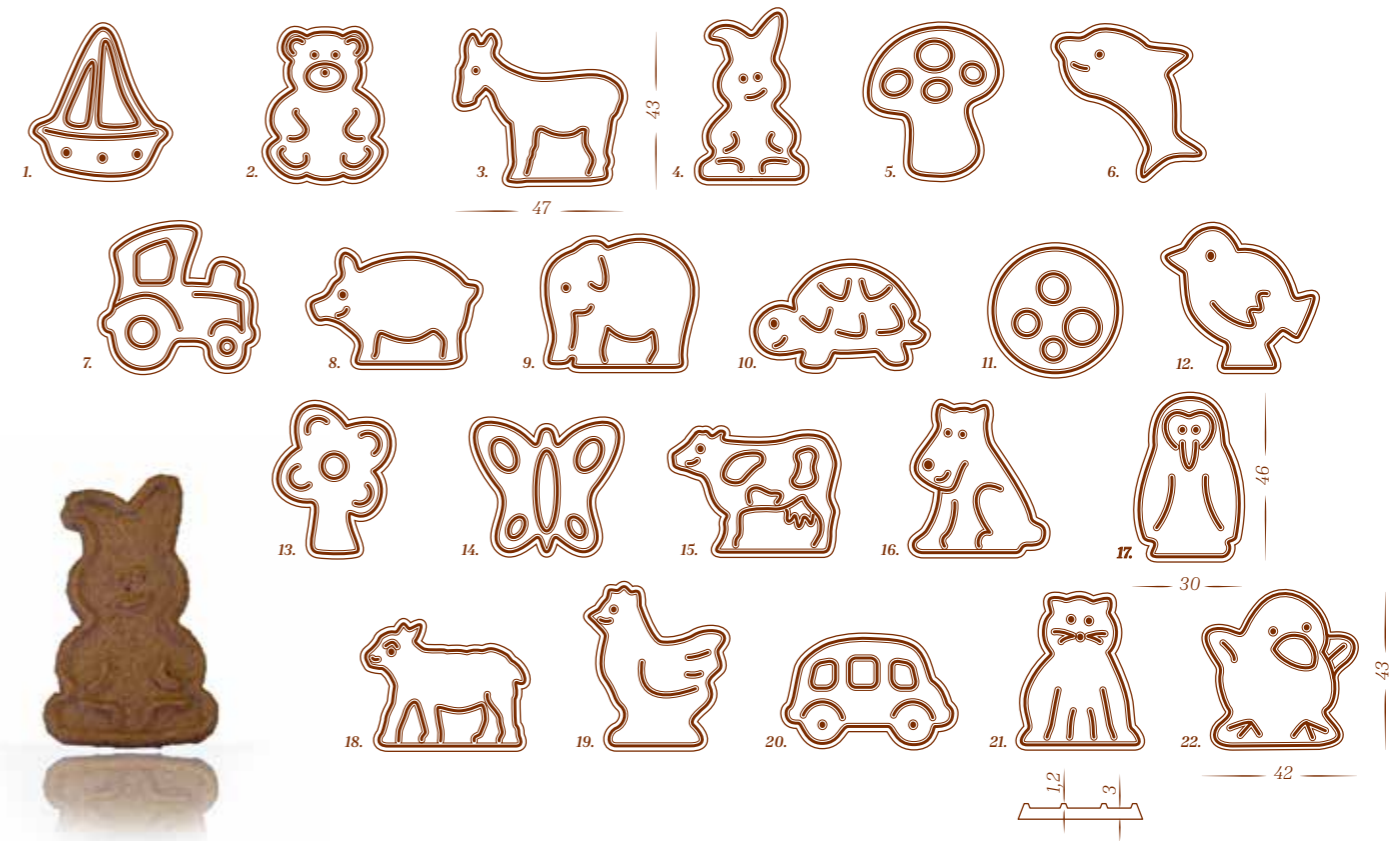

Janssens Kleine Welt Nr.: 1002 / 1-22. / Janssen's Little World No.: 1002 / 1-22.



»Janssens Halloween Welt« / »Janssen's Halloween World«

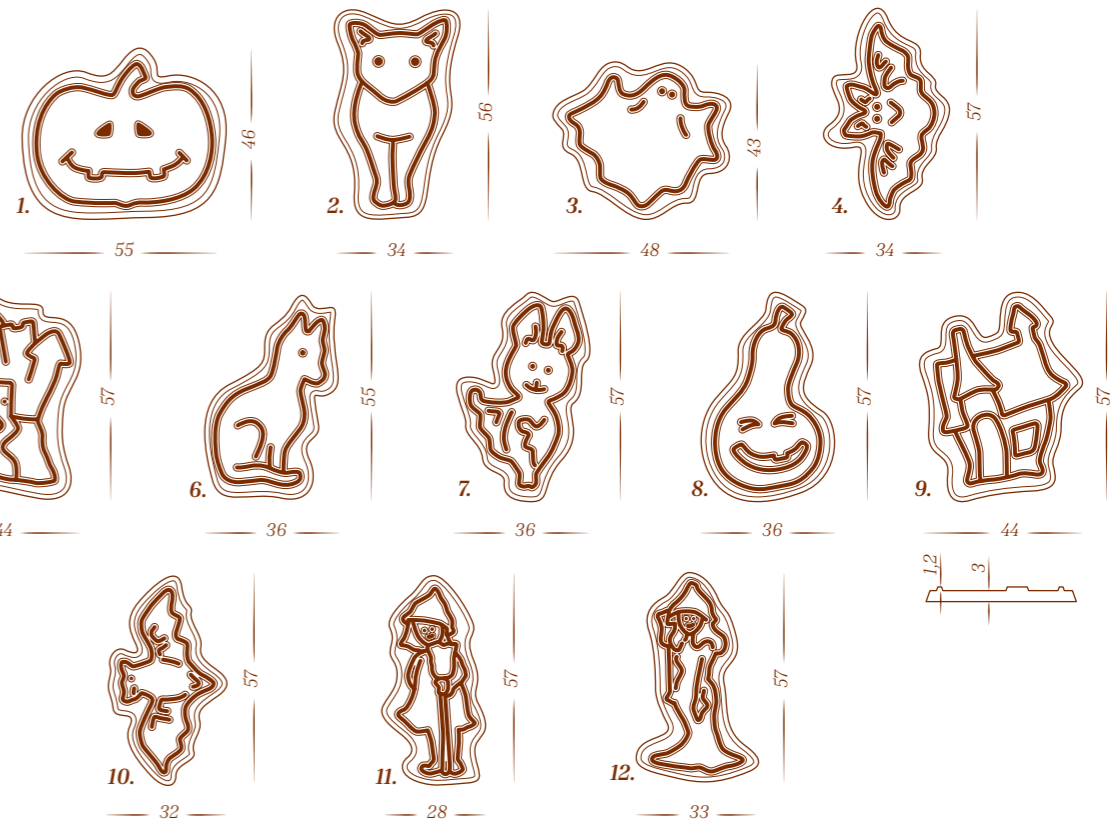

Janssens Halloween Nr.: 1003 / 1-12. / Janssen's Halloween World No.: 1003 / 1-12.



– 1004 –



»Janssens Osterwelt« / »Janssen's Easter World«



Janssens Osterwelt Nr.: 1004 / 1-9. / Janssen's Easter World No.: 1004/1-9.





– 1009 –



»Janssens Herbstwelt« / »Janssen's Autumn World«

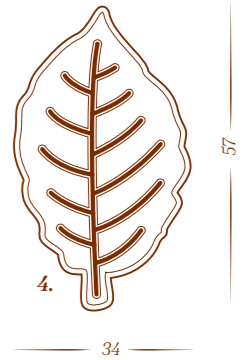
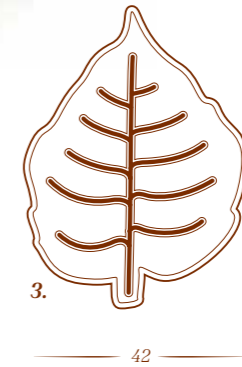
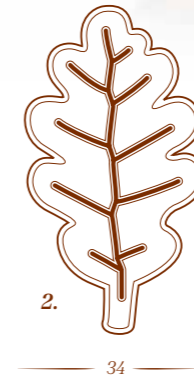
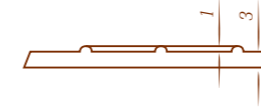
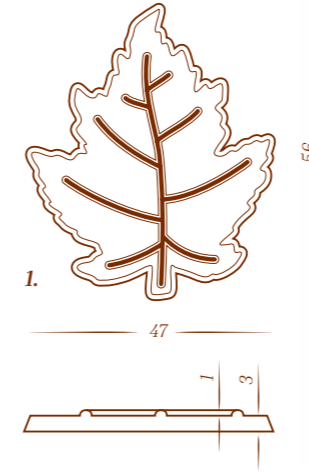

Janssens Herbstwelt Nr.: 1009 / 1-4. / Janssen's Autumn World No.: 1006 / 1-4.



– 1006 –



»Janssens Nikolauswelt« / »Janssen's Santa's World«



Janssens Nikolauswelt Nr.: 1006 / 1-10. / Janssen's Santa's World No.: 1006 / 1-10.



– 1001 –



»Janssens Weihnachtswelt« / »Janssen's Christmas World«



Janssens Weihnachtswelt Nr.: 1001 / 1-12. / Janssen's Christmas World No.: 1001 / 1-12.



– 1015 –



»Janssens Kleine Waldwelt« / »Janssen's Little Forest World«



Janssens Kleine Waldwelt Nr.: 1015 / 1-12. / Janssen's Little Forest World No.: 1015 / 1-12.



– 1005 –



»Janssens Märchenwelt« / »Janssen's Fairytale World«

<p>1.</p> <p>52</p> <p>39</p>	<p>2.</p> <p>47</p> <p>40</p>	<p>3.</p> <p>46</p> <p>51</p>	<p>4.</p> <p>55</p> <p>33</p>	<p>5.</p> <p>45</p> <p>42</p>
<p>6.</p> <p>48</p> <p>39</p>	<p>7.</p> <p>42</p> <p>47</p>	<p>8.</p> <p>46</p> <p>51</p>	<p>9.</p> <p>48</p> <p>37</p>	<p>10.</p> <p>48</p> <p>39</p>
<p>1,2</p> <p>3</p>				

Janssens Märchenwelt Nr.: 1005 / 1-10. / Janssen's Fairytale World No.: 1005 / 1-10.



- 1007 -



»Janssens Gute Besserung Welt« / »Janssen's Get Well World«

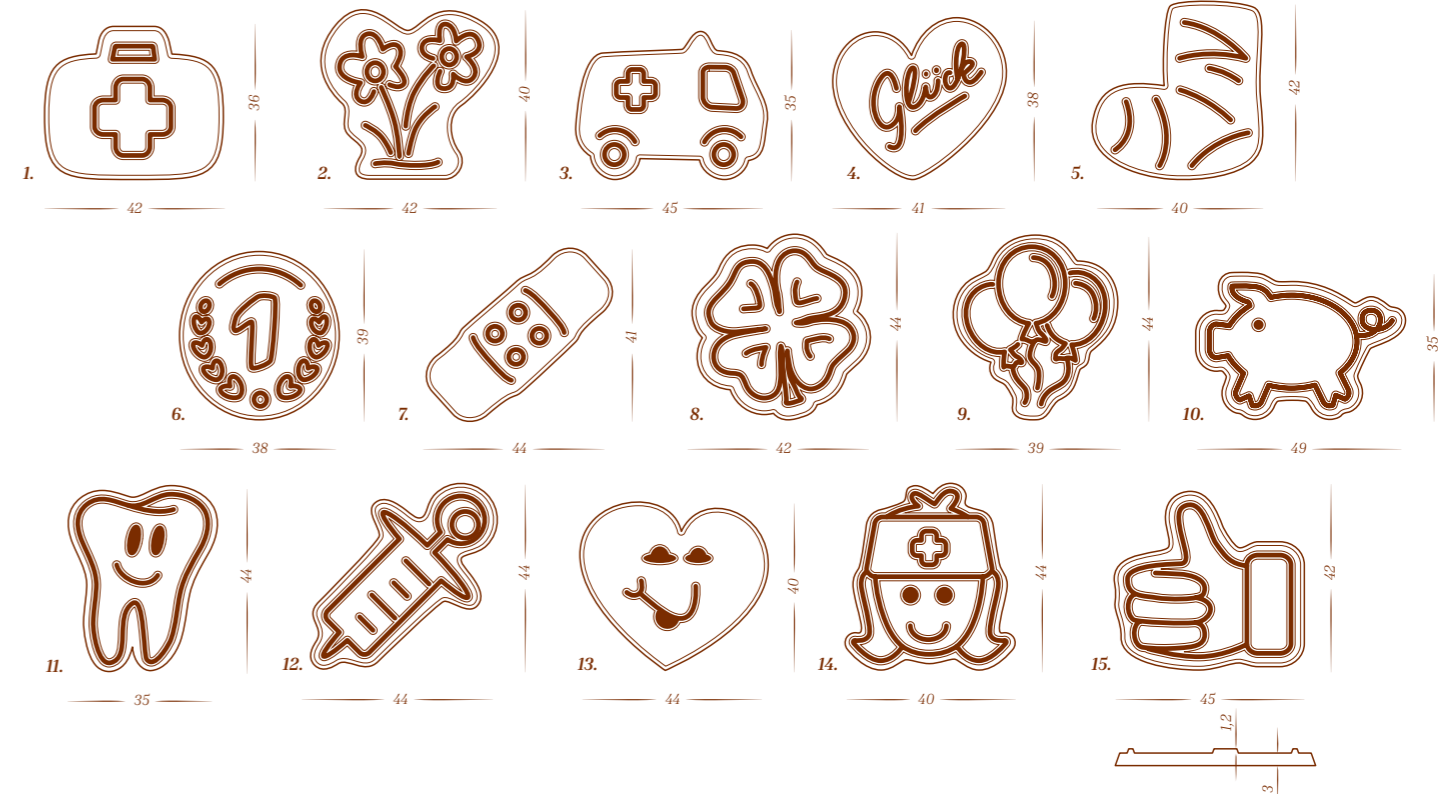

Janssens Gute Besserung Welt Nr.: 1007/1-15. / Janssen's Get Well World No.: 1007/1-15.



— 1024 —



»Janssens Meereswelt« / »Janssen's Sea World«

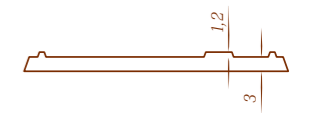
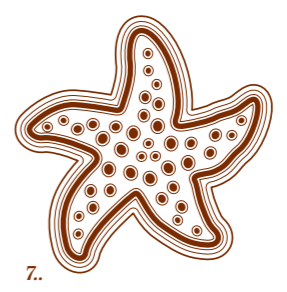
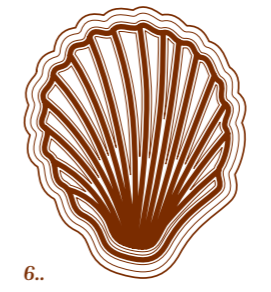
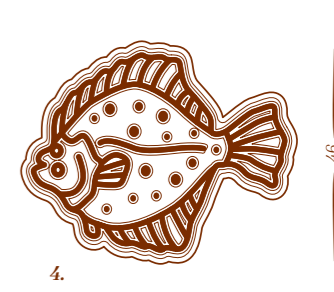

Janssens Meereswelt Nr.: 1024 / 1-7. / Janssen's Sea World No.: 1024 / 1-7.



- 0441 -



»Janssens Engelswelt« / »Janssen's Angel World«



Janssens Engelswelt Nr.: 0441 / 1-12. / Janssen's Angel World No.: 0441 / 1-12.





– 4102 –



»Janssens Feines Teegebäck« / »Janssen's Fine Tea Biscuits«

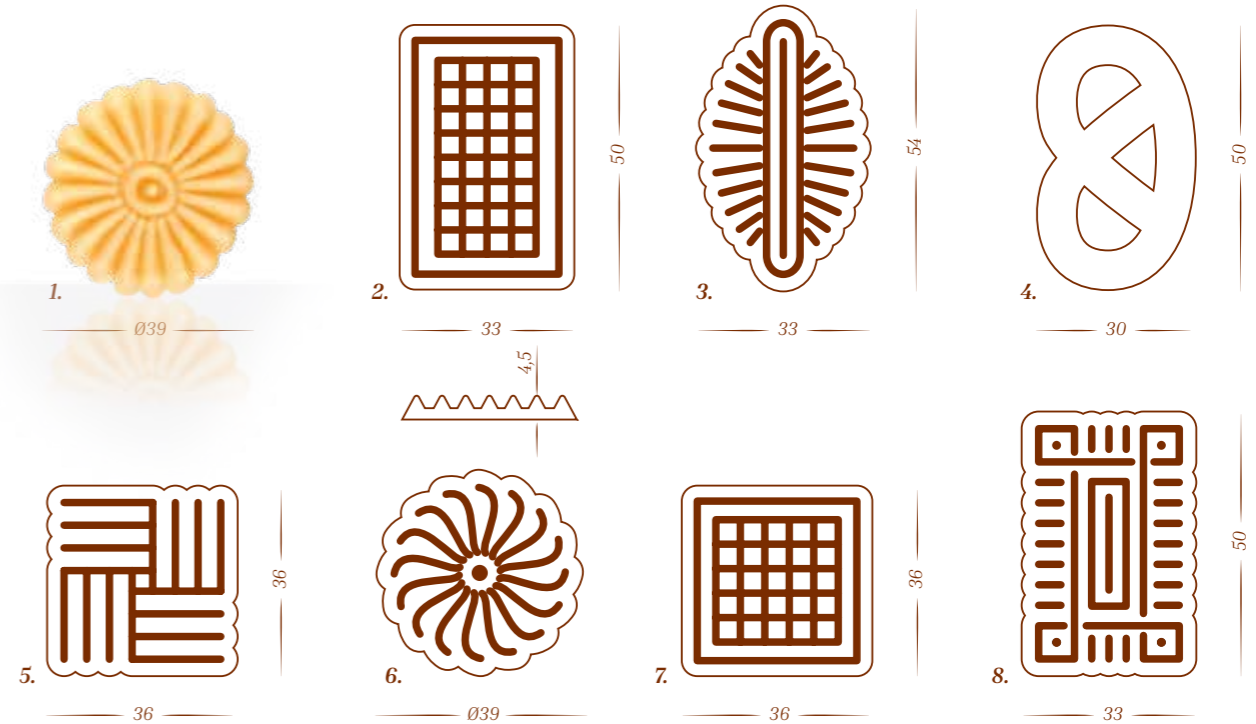

Janssens Feines Teegebäck Nr.: 4102 / 1-8. / Janssen's Fine Tea Biscuits No.: 4102 / 1-8.



- 4476 -



»Janssens Teegebäck 1« / »Janssen's Tea Biscuits 1«



Janssens Teegebäck 1 Nr.: 4476 / 1-10. / Janssen's Fine Tea Biscuits 1 No.: 4476 / 1-10.



– 4478 –



»Janssens Teegebäck 2« / »Janssen's Tea Biscuits 2«

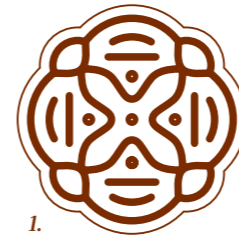

1.

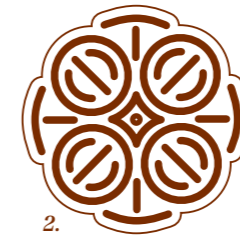

2.



3.



4.



5.



6.



7.

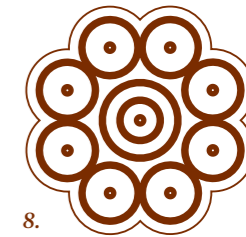

8.

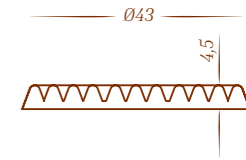

Janssens Teegebäck 2 Nr.: 4478 / 1-8. / Janssen's Tea Biscuits No.: 4478 / 1-8.



– 4470 –



»Janssens Griechisches Gebäck« / »Janssen's Greek Pastry«



1.



2.



3.

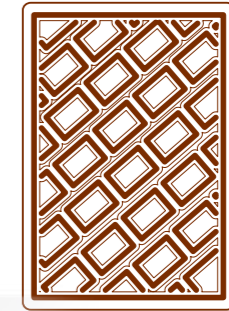

4.

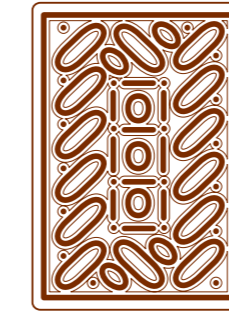

5.

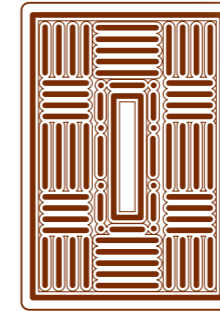

6.

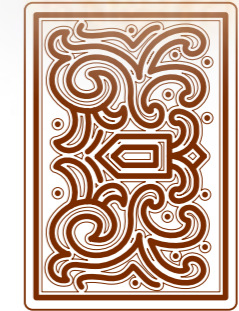

7.

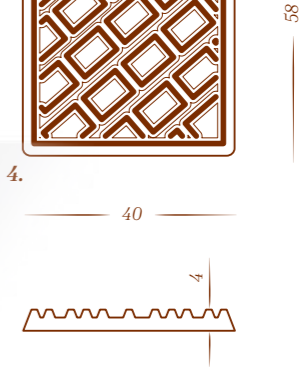

Janssens Griechisches Gebäck Nr.: 4470 / 1-7. / Janssen's Greek Pastry No.: 4470 / 1-7.



- 4471 -



»Janssens Spanisches Gebäck« / »Janssen's Spanish Pastry«



1.



2.

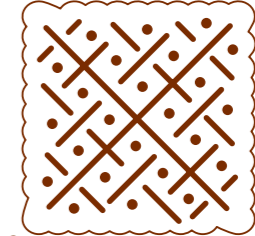

3.



4.



5.



6.

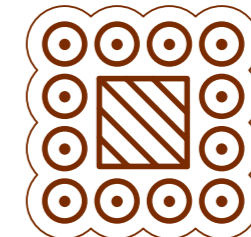

7.



8.

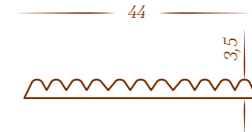

Janssens Spanisches Gebäck Nr.: 4471 / 1-8. / Janssen's Spanish Pastry No.: 4471 / 1-8.



— 4474 —



»Janssens Dekorgebäck« / »Janssen's Decorative Biscuits«

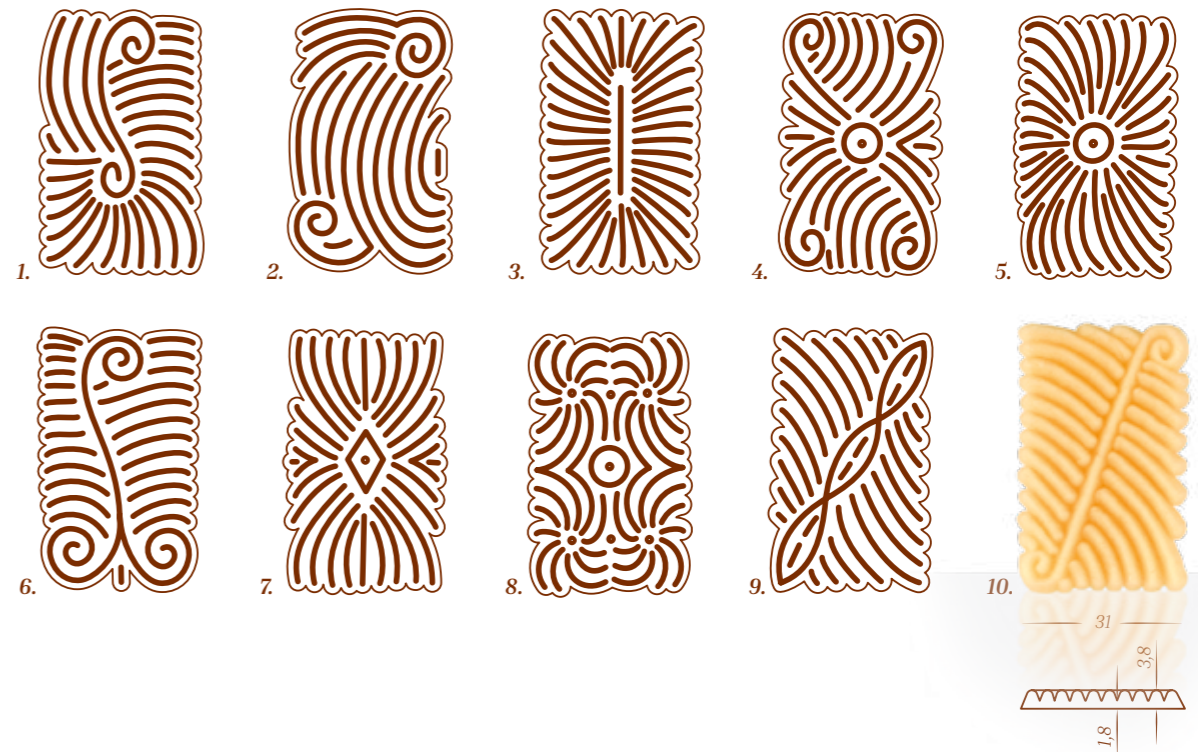

Janssens Dekorgebäck Nr.: 4474 / 1-10. / Janssen's Decorative Biscuits No.: 4474 / 1-10.



– 1013 –



»Janssens Schneeflocken« / »Janssen's Snowflakes«

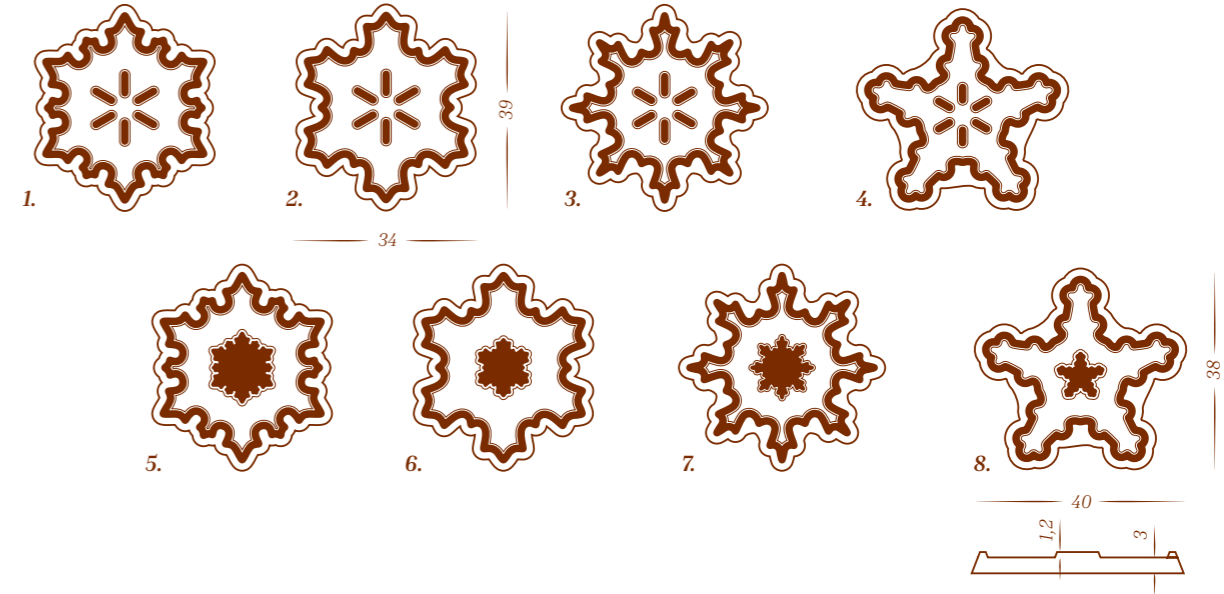

Janssens Schneeflocken Nr.: 1013 / 1-8. / Janssen's Snowflakes No.: 1013 / 1-8.



- 1016 -

»Janssens Flora« / »Janssen's Flora«

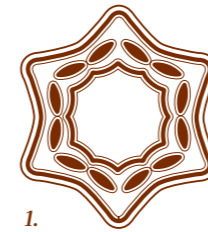

1.

37

42

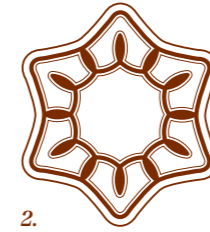

2.

37

42

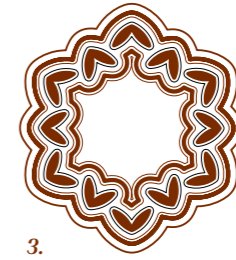

3.

42

47

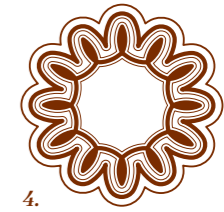

4.

38

38

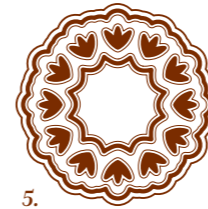

5.

37

38



6.

40

45

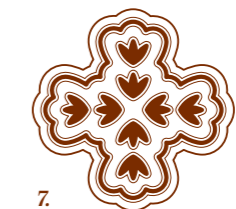

7.

38

38



8.

36

36

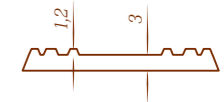

Janssens Flora Nr.: 1016 / 1-8. / Janssen's Flora No.: 1016 / 1-8.





— 1017 —



»Janssens Ornamentgebäck« / »Janssen's Ornamental Biscuits«

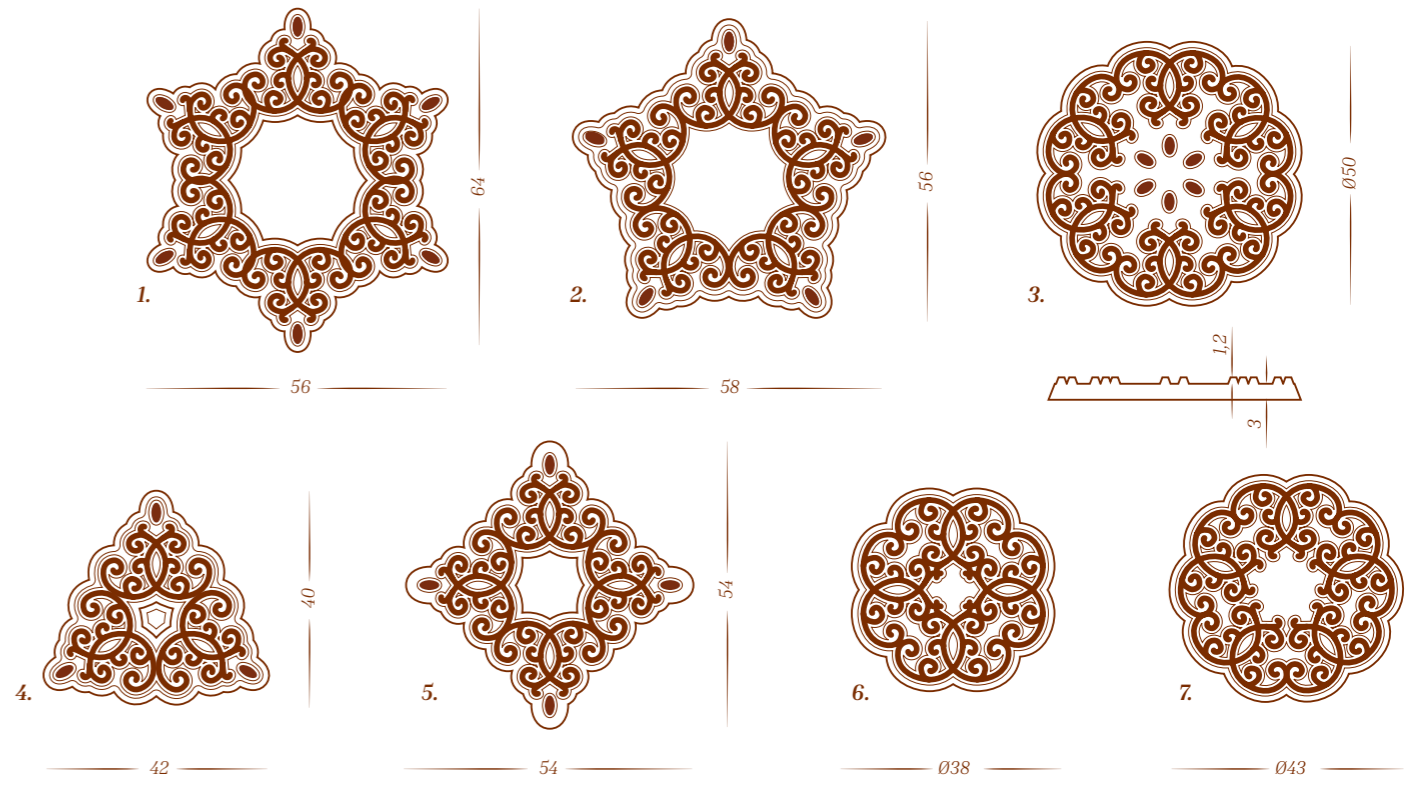

Janssens Ornamentgebäck Nr.: 1017 / 1-7. / Janssen's Ornamental Biscuits No.: 1017 / 1-7.



– 1018 –



»Janssens Kristalle« / »Janssen's Crystals«

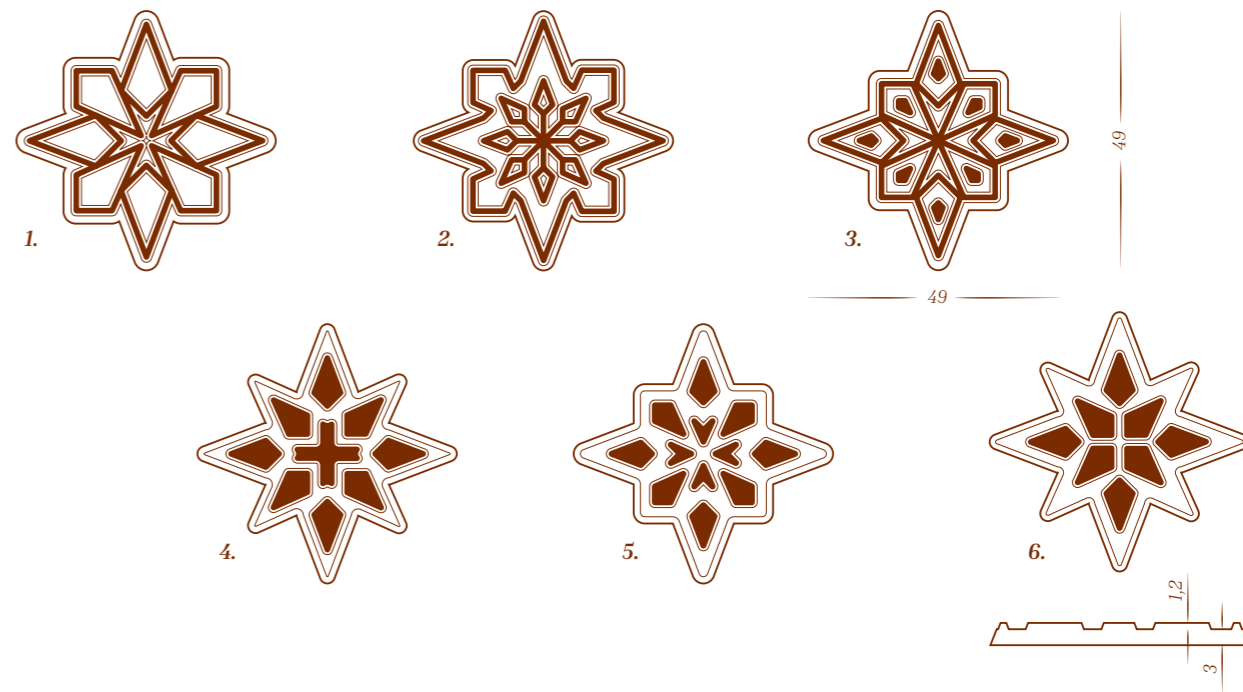

Janssens Kristalle Nr.: 1018 / 1-6. / Janssen's Crystals No.: 1018 / 1-6.



— 1019 —



»Janssens Mandalas« / »Janssen's Mandalas«

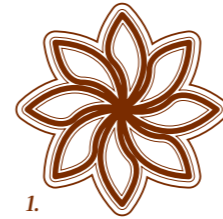

1.

Ø40

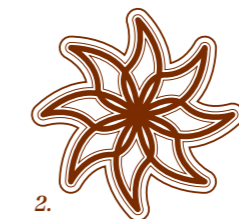

2.

Ø40

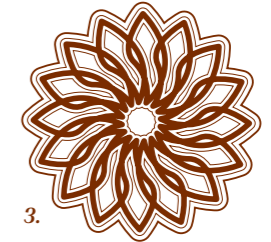

3.

Ø45

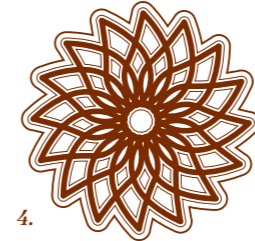

4.

Ø45

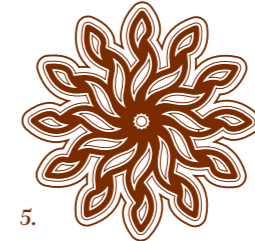

5.

Ø45



6.

Ø45

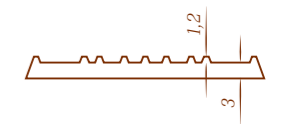

Janssens Mandalas Nr.: 1019 / 1-6. / Janssen's Mandalas No.: 1019 / 1-6.



– 1020 –



## »Janssens süße Zungen« / »Janssen's Sweet Tongues«

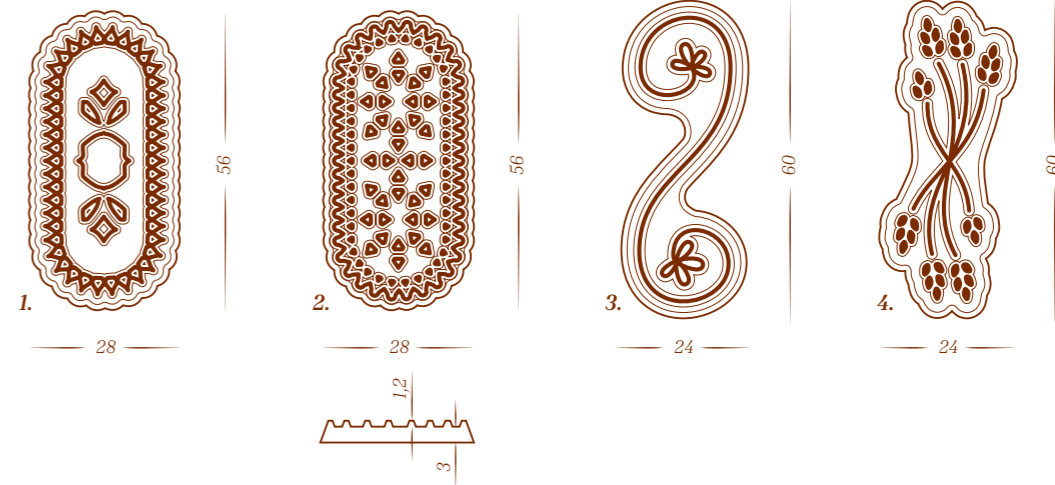

Janssens süße Zungen Nr.: 1020 / 1-4. / Janssen's Sweet Tongues No.: 1020 / 1-4.

Janssen

- 1021 -



»Janssens Feinstes« / »Janssen's Finest«



1.

Ø45

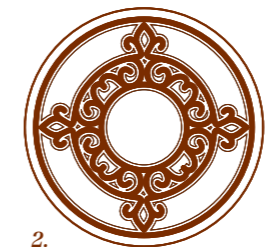

2.

Ø45

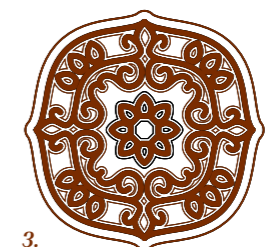

3.

Ø45



4.

Ø45

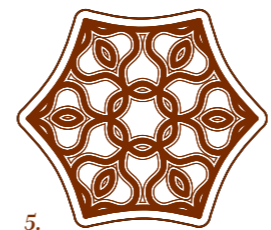

5.

47



6.

44

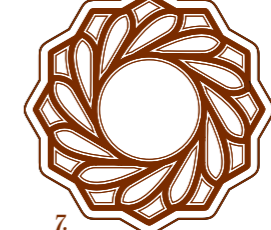

7.

Ø47

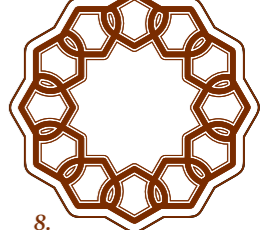

8.

Ø47

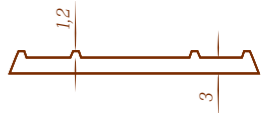

Janssens Feinstes Nr.: 1021 / 1-8. / Janssen's Finest No.: 1021 / 1-8.



– 1022 –

»Janssens Geschenke« / »Janssen's Presents«

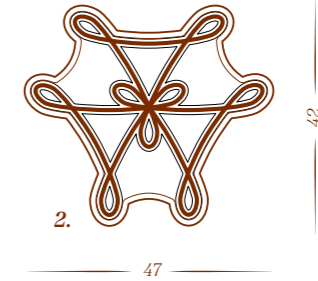
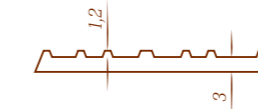
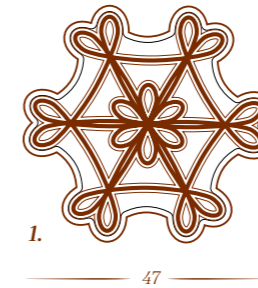

Janssens Geschenke Nr.: 1022 / 1-2. / Janssen's Presents No.: 1022 / 1-2.



- 1023 -



## »Janssens Prismen« / »Janssen's Prisms«

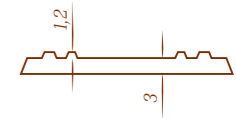
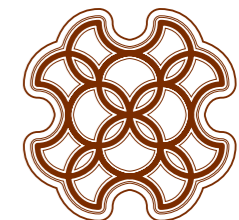
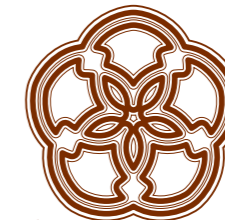
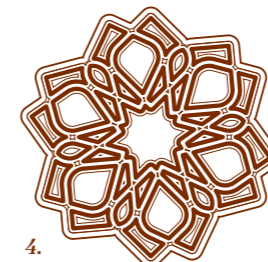
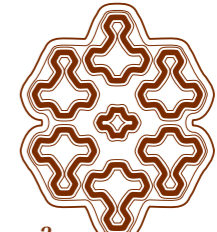
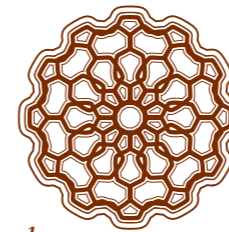

Janssens Prismen Nr.: 1023 / 1-6. / Janssen's Prisms No.: 1023 / 1-6.

Janssen

– 4106 –



»Janssens Spritzgebäck« / »Janssen's Shortbread«

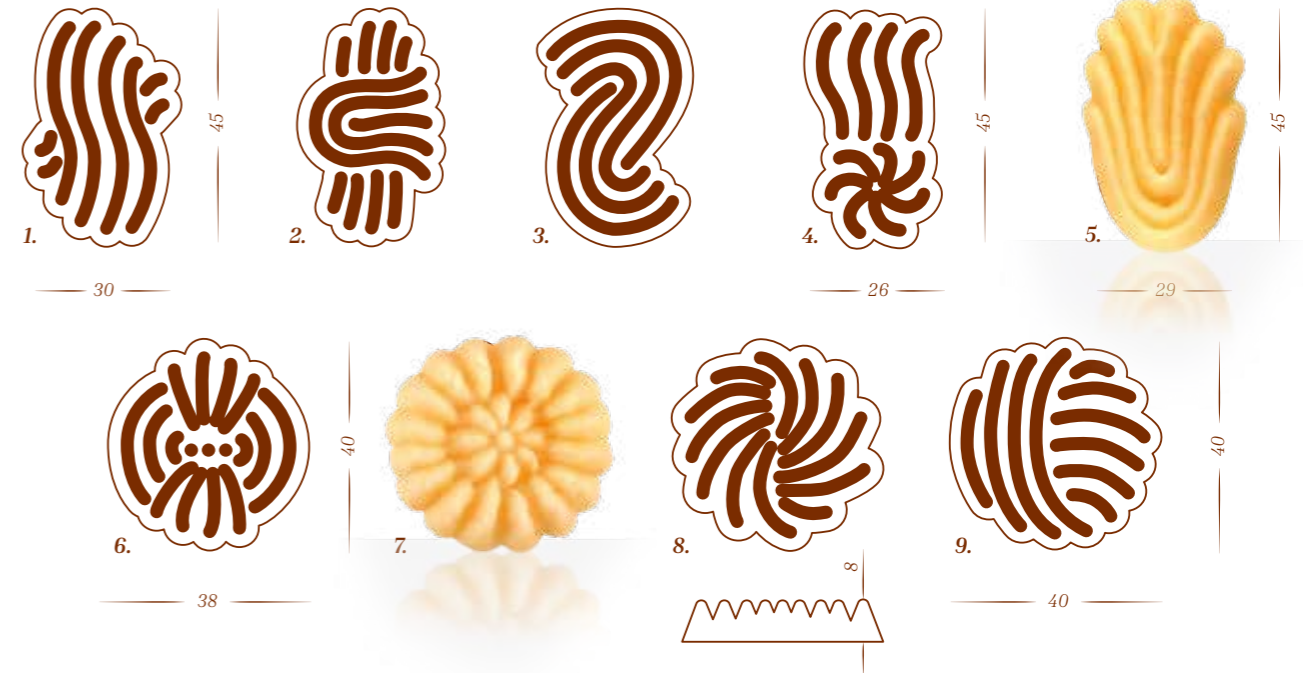

Janssens Spritzgebäck Nr.: 4106 / 1-9. / Janssen's Shortbread No.: 4106 / 1-9.





– 0001 –



»Janssens Omakeks« / »Janssen's Granny Biscuit«

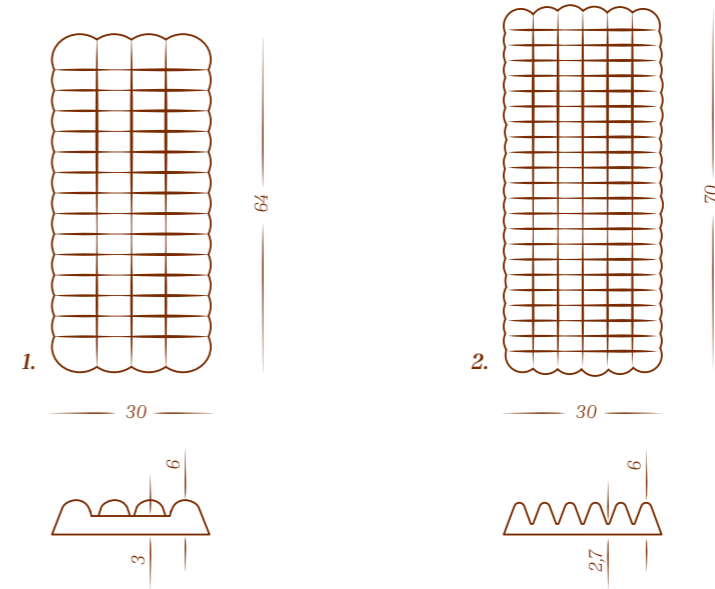

Janssens Omakeks Nr.: 0001/1-2. / Janssen's Granny Biscuit No.: 0001/1-2.



– 1017 –



»Janssens Torteletts« / »Janssen's Tartlets«

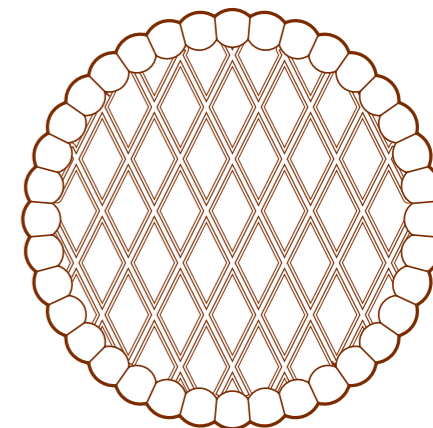
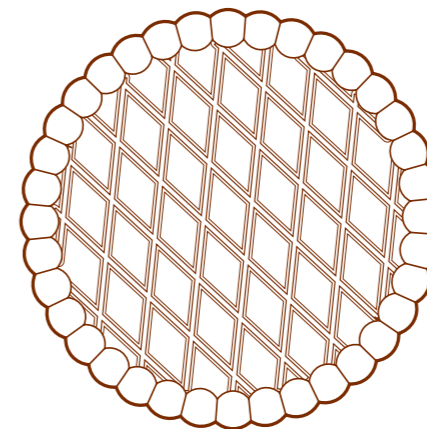

Ø90

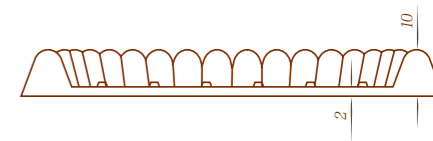

Janssens Torteletts Nr.: 1017 / Janssen's Tartlets No.: 1017



– 1000 –



»Janssens Kleine Spekuwelt« / »Janssen's Little Speculoos World«



Janssens Kleine Spekuwelt Nr.: 1000 / 1-14. / Janssen's Little Speculoos World No.: 1000/1-14.



## »Individuelle Designs«

### Soll es etwas besonderes sein?

Entdecken Sie die gestalterischen Möglichkeiten für Ihre individuellen und unverwechselbaren Kekse:

Von Ihrer gebackenen Visitenkarte, Ihrem Logo bis hin zu ganz individuellen grafischen Motiven und Mustern.

Kontaktieren Sie uns und schicken Sie uns ein Foto /Skizze oder beschreiben Sie uns Ihr Wunschgebäck und nennen Sie uns die Maße des ungebackenen Kekses.

### Ihr Weg zu Ihrer individuellen Formwalze:

☛ schicken Sie uns ein Foto /Skizze oder beschreiben Sie uns Ihr Wunschgebäck

☛ nennen Sie uns die Maße des ungebackenen Kekses: Länge / Breite / Höhe in mm

## »Individual designs«

### Would you like something special?

Discover the design possibilities for your individual and distinctive biscuits:

From your baked business card, your logo to completely individual graphic motifs and patterns.

Contact us and send us a photo/sketch or describe your desired biscuit and tell us the dimensions of the unbaked biscuit.

### Your way to your individual forming roller:

☛ send us a photo / sketch or describe your desired biscuit

☛ tell us the dimensions of the unbaked biscuit: length / width / height in mm.

Preise auf Anfrage... / Prices on request...



– Indi –

Preise auf Anfrage... / Prices on request...



### Beispiel: »Runde Gebäcke« / Example: »Round Biscuits«

Runde Gebäcke mit Gebäckdicken und Durchmessern nach Ihren Vorgaben. Preise auf Anfrage...

Round pastries with pastry thicknesses and diameters according to your specifications. Prices On request...

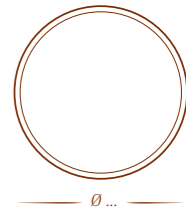
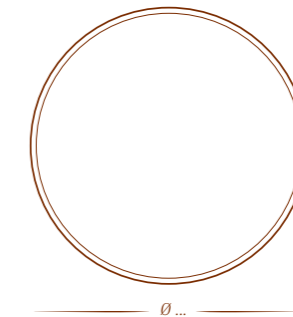
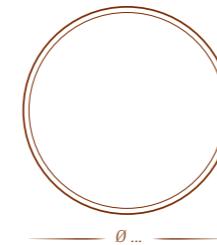
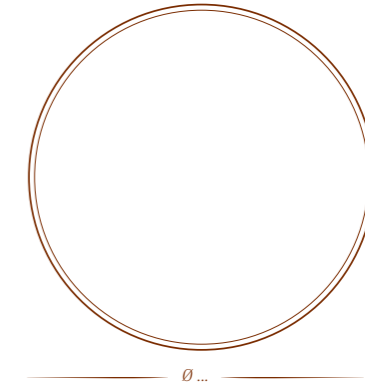
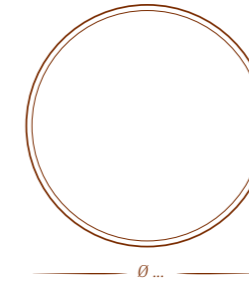

– Indi –

Preise auf Anfrage... / Prices on request...



Beispiel: »... mit Wellenrand« / Example: »... with scalloped edge«

Gebäcke mit gewelltem Rand mit Gebäckdicken und Durchmessern nach Ihren Vorgaben. Preise auf Anfrage...

Biscuits with scalloped edges with biscuit thicknesses and diameters according to your specifications. Prices on request...

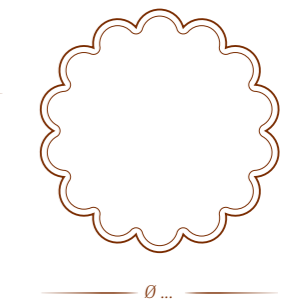
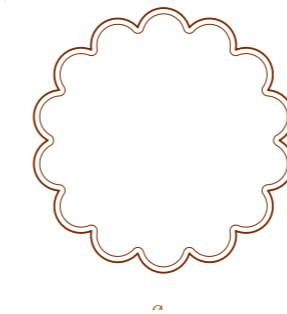
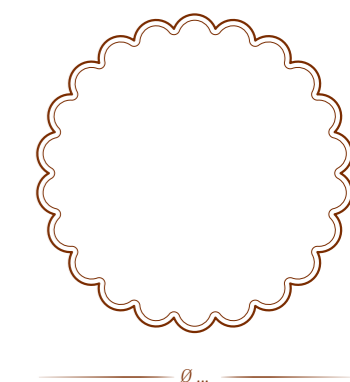
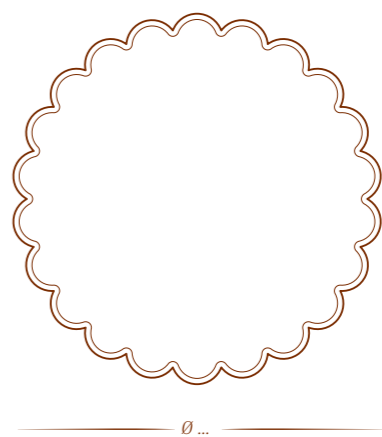
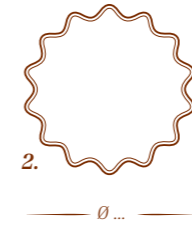
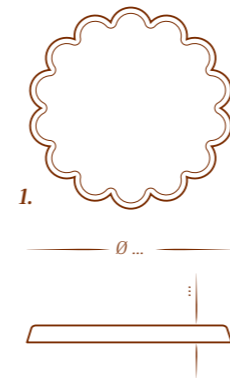

– Indi –

Preise auf Anfrage... / Prices on request...

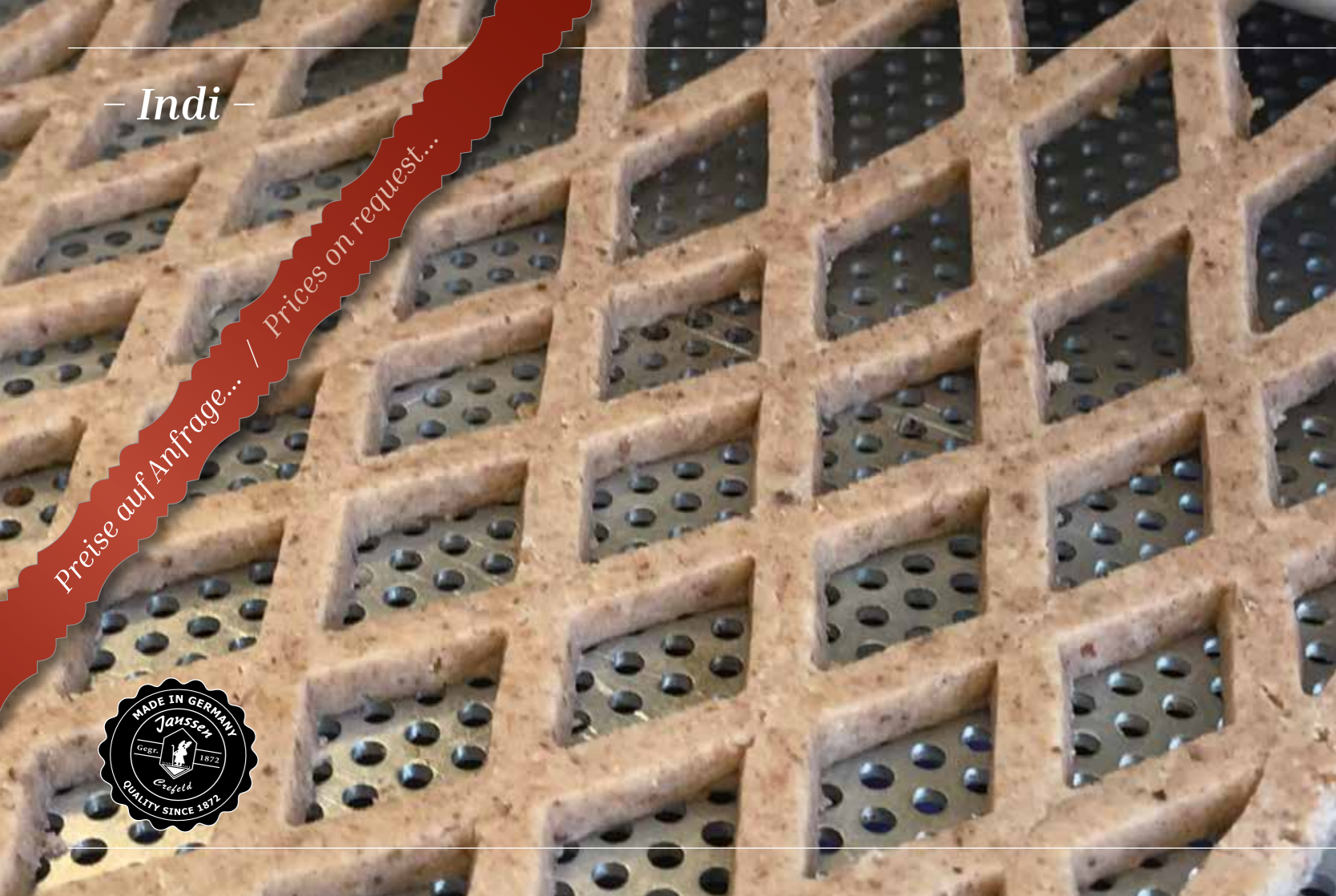

Beispiel: »Gitter« / Example: »Lattice«

Gebäckdicken und Abmessungen nach Ihren Vorgaben.  
Preise auf Anfrage...

Pastry thicknesses and dimensions according to your specifications. Prices on request...

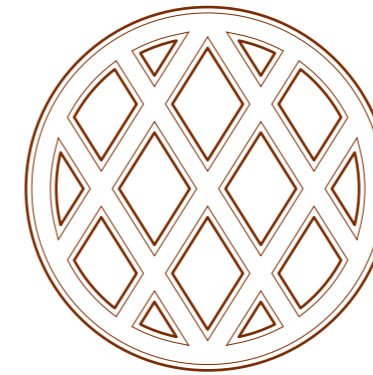

Ø ...

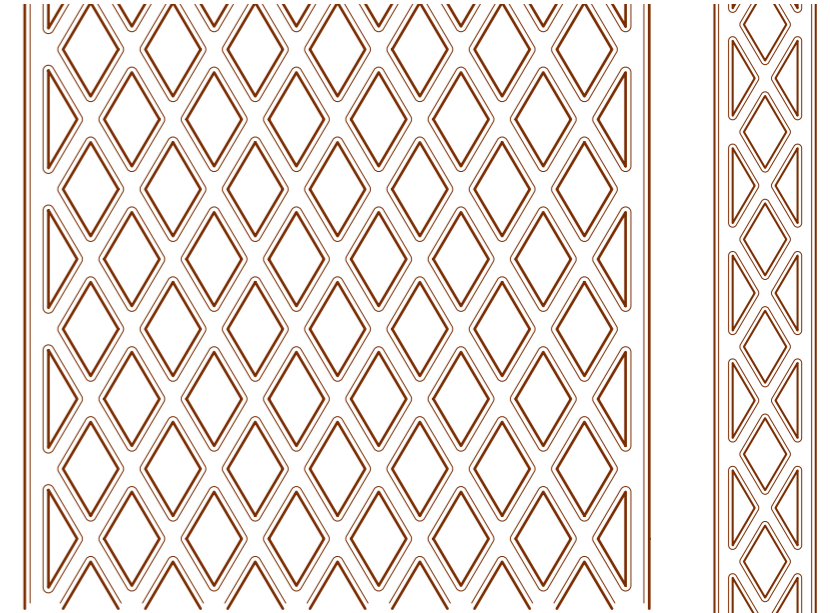



*Wir wünschen Ihnen viel Freude mit  
Ihrem Janssen-Gebäckformer!*

*We hope you enjoy using your  
Janssen Cooky Formers!*







Niederrheinische Formenfabrik  
Janssen GmbH

Moerser Straße 33  
47798 Krefeld

Tel. +49 (0) 2151 2431  
Fax +49 (0) 2151 29759

info@nff-janssen.de  
www.nff-janssen.de

